

Morbella

TX1



USER MANUAL

Trademarks

All brand and product names are trademarks or registered trademarks of Maka GPS Technologies Group. In association with Maka GPS Technologies Private Limited (Singapore), Maka GPS Technologies Sdn. Bhd. (Malaysia), Maka Technologies Group (H.K.) Limited. and Maka Corporation USA Inc.

The information in this manual is subject to change without notice.

www.makagps.com

2/2018. R1.2



Safety information

To prevent injury to yourself and others or damage to your device, read the safety information about your device before using the device.



Warning

Failure to comply with safety warnings and regulations can cause serious injury or death.

Do not use damaged power cords or plugs, or loose electrical sockets

Unsecured connections can cause electric shock or fire.

Do not touch the car charger with wet hands or disconnect the charger by pulling the cord

Doing so may result in electrocution.

Do not bend or damage the car charger

Doing so may cause electric shock or fire.

Do not use your device while it is charging or touch your device with wet hands

Doing so may cause electric shock.

Do not short-circuit the charger or the device

Doing so may cause electric shock or fire, or the battery may malfunction or explode.

Morbella

Use manufacturer-approved batteries, chargers, accessories, and supplies

- Using generic batteries or chargers may shorten the life of your device or cause the device to malfunction. They may also cause a fire or cause the battery to explode.
- Use only Maka GPS Technologies Group-approved battery and charger specifically designed for your device. Incompatible battery and charger can cause serious injuries or damage to your device.
- Maka GPS Technologies Group cannot be responsible for the user's safety when using accessories or supplies that are not approved by Maka GPS Technologies Group.

Do not drop or cause an impact to the charger or the device.

Handle and dispose of the device and charger with care

- Never dispose of the battery or device in a fire. Never place the battery or device on or in heating devices, such as microwave ovens, stoves, or radiators. The device may explode when overheated. Follow all local regulations when disposing of used battery or device.
- Never crush or puncture the device.
- Avoid exposing the device to high external pressure, which can lead to an internal short circuit and overheating.

Protect the device, battery and charger from damage

- Avoid exposing your device and battery to very cold or very hot temperatures.

Morbella

- Extreme temperatures can damage the device and reduce the charging capacity and life of your device and battery.
- Prevent the battery from coming into contact with metal objects, as this can create a connection between the + and – terminals of your battery and lead to temporary or permanent battery damage.
- Never use a damaged charger or battery.

Do not bite or suck the device or the battery

- Doing so may damage the device or result in an explosion or fire. • Children or animals can choke on small parts.
- If children use the device, make sure that they use the device properly.

Do not handle a damaged or leaking Lithium Ion (Li-Ion) battery

For safe disposal of your Li-Ion battery, contact your nearest authorised service centre



Caution

Failure to comply with safety cautions and regulations can cause injury or property damage

Do not use your device near other electronic devices

Most electronic devices use radio frequency signals. Your device may interfere with other electronic devices.

Do not expose the device to heavy smoke or fumes

Doing so may damage the outside of the device or cause it to malfunction.

Do not use your device near devices or apparatuses that emit radio frequencies, such as sound systems or radio towers

Radio frequencies may cause your device to malfunction.

If you notice strange smells or sounds coming from your device or the battery, or if you see smoke or liquids leaking from the device or battery, stop using the device immediately and take it to a Maka Service Centre

Failure to do so may result in fire or explosion.

For your own safety, do not operate the controls of the product while driving.

Two window mounts are needed when using the recorder in a car. Make sure that you place the recorder in an appropriate place, so as not to obstruct the driver's view.

Make sure that no object is blocking the camera lens and no reflective material appears near the lens.

Please keep the lens clean. If the car's windscreen is tinted with a dark solar film coating, it may affect the recording quality.

Morbella

Do not store your device in very hot or very cold areas. It is recommended to use your device at temperatures from 0 °C to 60 °C and humidity from 10% to 80%

Doing so may cause the screen to malfunction, result in damage to the device, or cause the battery to explode.

Do not use your device or applications for a while if the device is overheated

Prolonged exposure of your skin to an overheated device may cause low temperature burn symptoms, such as red spots and pigmentation.

Install mobile devices and equipment with caution

- Ensure that any mobile devices or related equipment installed in your vehicle are securely mounted.
- Avoid placing your device and accessories near or in an airbag deployment area. Improperly installed wired equipment can cause serious injury when airbags inflate rapidly.

Do not drop your device or cause impacts to your device

- Your device may be damaged or may malfunction.
- If bent or deformed, your device may be damaged or parts may malfunction.

Ensure maximum battery and charger life

- Avoid charging your device for more than a week, as overcharging may shorten battery life.
- Over time, unused device will discharge and must be recharged before use.
- Disconnect the charger from power sources when not in use.

Morbella

- Leaving batteries unused over time may reduce their lifespan and performance. It may also cause the batteries to malfunction or explode, or cause a fire.
- Your device may wear out over time. Some parts and repairs are covered by the warranty within the validity period, but damages or deterioration caused by using unapproved accessories are not.

Do not disassemble, modify, or repair your device

- Any changes or modifications to your device can void your manufacturer's warranty. If your device needs servicing, take your device to a Maka Service Centre.
- Do not disassemble or puncture the battery, as this can cause explosion or fire.
- Turn off the device before removing the battery. If you remove the battery with the device turned on, it may cause the device to malfunction.

When cleaning your device, mind the following

- Wipe your device or charger with a towel or an eraser.
- Do not use chemicals or detergents. Doing so may discolour or corrode the outside the device or may result in electric shock or fire.

Do not distribute copyright-protected material

Do not distribute copyright-protected material without the permission of the content owners. Doing this may violate copyright laws. The manufacturer is not liable for any legal issues caused by the user's illegal use of copyrighted material.

Correct disposal of this product



(Waste Electrical & Electronic Equipment)

(Applicable in countries with separate collection systems)

This marking on the product, accessories or literature indicates that the product and its electronic accessories (e.g. charger, headset, USB cable) should not be disposed off with other household waste.

To prevent possible harm to the environment or human health from uncontrolled waste disposal, please separate these items from other types of waste and recycle them responsibly to promote the sustainable reuse of material resources.

Household users should contact either the retailer where they purchased this product, or their local government office, for details of where and how they can take these items for environmentally safe recycling.

Business users should contact their supplier and check the terms and conditions of the purchase contract. This product and its electronic accessories should not be mixed with other commercial wastes for disposal.



Disclaimer

Some content and services accessible through this device belong to third parties and are protected by copyright, patent, trademark and/or other intellectual property laws. Such content and services are provided solely for your personal non-commercial use.

You may not use any content or services in a manner that has not been authorised by the content owner or service provider. Without limiting the foregoing, unless expressly authorised by the applicable content owner or service provider, you may not modify, copy, republish, upload, post, transmit, translate, sell, create derivative works, exploit, or distribute in any manner or medium any content or services displayed through this device.

"THIRD PARTY CONTENT AND SERVICES ARE PROVIDED "AS IS." MAKa GPS TECHNOLOGIES GROUP DOES NOT WARRANT CONTENT OR SERVICES SO PROVIDED, EITHER EXPRESSLY OR IMPLIEDLY, FOR ANY PURPOSE. MAKa EXPRESSLY DISCLAIMS ANY IMPLIED WARRANTIES, INCLUDING BUT NOT LIMITED TO, WARRANTIES OF MERCHANTABILITY OR FITNESS FOR A PARTICULAR PURPOSE. MAKa GPS TECHNOLOGIES GROUP DOES NOT GUARANTEE THE ACCURACY, VALIDITY, TIMELINESS, LEGALITY, OR COMPLETENESS OF ANY CONTENT OR SERVICE MADE AVAILABLE THROUGH THIS DEVICE AND UNDER NO CIRCUMSTANCES, INCLUDING NEGLIGENCE, SHALL MAKa GPS TECHNOLOGIES GROUP BE LIABLE, WHETHER IN CONTRACT OR TORT, FOR ANY DIRECT, INDIRECT, INCIDENTAL, SPECIAL OR CONSEQUENTIAL DAMAGES, ATTORNEY FEES, EXPENSES, OR ANY OTHER DAMAGES ARISING OUT OF, OR IN CONNECTION WITH, ANY INFORMATION CONTAINED IN, OR AS A RESULT OF THE USE OF ANY CONTENT OR SERVICE BY YOU OR ANY THIRD PARTY, EVEN IF ADVISED OF THE POSSIBILITY OF SUCH DAMAGES."

Third party services may be terminated or interrupted at any time, and Maka GPS Technologies Group makes no representation or warranty that any

Morbella

content or service will remain available for any period of time. Content and services are transmitted by third parties by means of networks and transmission facilities over which Maka GPS Technologies Group has no control. Without limiting the generality of this disclaimer, Maka GPS Technologies Group expressly disclaims any responsibility or liability for any interruption or suspension of any content or service made available through this device.

Maka GPS Technologies Group is neither responsible nor liable for customer service related to the content and services. Any question or request for service relating to the content or services should be made directly to the respective content and service providers.



About this manual

This device provides high quality digital recording device using Maka's high standards and technological expertise. This user manual is specially designed to detail the device's functions and features.

- Please read this manual before using the device to ensure safe and proper use. Descriptions are based on the device's default settings.
- Images and screenshots may differ in appearance from the actual product.
- Content may differ from the final product, or from software provided by service providers and is subject to change without prior notice.
- For the latest version of the manual, refer to the Maka website at www.makagps.com.
- Available features and additional services may vary by device, software.
- Applications and their functions may vary by country, region, or hardware specifications.
- Maka is not liable for performance issues caused by applications from any provider other than Maka.
- Maka is not liable for performance issues or incompatibilities caused by not installing the device as stated in this manual. Attempting to customise the installation may cause the device or applications to work improperly. This may result in device malfunctions and data corruption or loss. These actions are violations of your Maka agreement and will void your warranty.
- Default applications that come with the device are subject to updates and may no longer be supported without prior notice. If you have questions about an application provided with the device, contact Maka Service Centre.



Table of Contents

Product Specifications	14
Getting Started	
Overview of your TX1 FHD Digital Roadcorder™	
Device Layout / Button Function	15
Understanding of your TX1 FHD Digital Roadcorder™	
Buttons	16
Status Icons	17
Standard Packaging of your TX1 FHD Digital Roadcorder™	
Package Contents	18
<u>Installation for your TX1 FHD Digital Roadcorder™</u>	
Installation	19
Charging the Battery	20
Inserting Memory Card	21
Removing / Formatting Memory Card	22
Operation of your TX1 FHD Digital Roadcorder™	
<u>Video / System Setting</u>	
Turning the device on and off	23
Resolution	24
Loop Recording	24-25
HDR	25-26
Motion Detector	26
Record Audio	27
Date Stamp	27-28
Gravity Sensor	28
Date / Time	29
Car No Stamp	29-30

Table of Contents

Operation of your TX1 FHD Digital Roadcorder™

Auto Power Off	30
Beep Sound	30-31
Language	31
Frequency	32
LCD Time Out	32-33
Exposure	33
Anti-Shaking	34
Delay Shutdown	34-35
Format	35
Default Setting	36
Version	36

PHOTO SETTING

Capture Mode	37
Resolution	37-38
Sequence	38
Quality	38-39
Sharpness	39
White Balance	39-40
Color	40
ISO	41
Date Stamp	41
Playback Mode (Video/Photo)	42
Delete / ProtectFiles	43
General Troubleshooting	44 - 45



Product Specifications



Sensor	3MP Sony323 sensor
Lens	Fixed focus, 4 layer glasses Lens
Aperture	F=2.2, f=2.1 , FOV : 170°
CPU	NTK96658
External Memory	Class 10 or above TF card(SDHC specification up to 64G)
Gravity sensor	Sensitivity low/medium/high/OFF
LCD	3.0 inch 16:9 TFT LCD
Audio	Built-in high sensitivity microphone/speaker
Motion detect	ON/OFF
Shutter	Electronic shutter
White balance	Auto
Exposure	Auto ISO
Language	English, Traditional Chinese, Simplified Chinese, Russian
Battery (optional)	200mAh 3.7V rechargeable lithium battery
Video format	MOV
Video resolution	1920x1080P30, 1280x720P30
Loop recording	OFF/1 min/3 min/5 min
Microphone mute	ON/OFF

Device Layout / Button Function

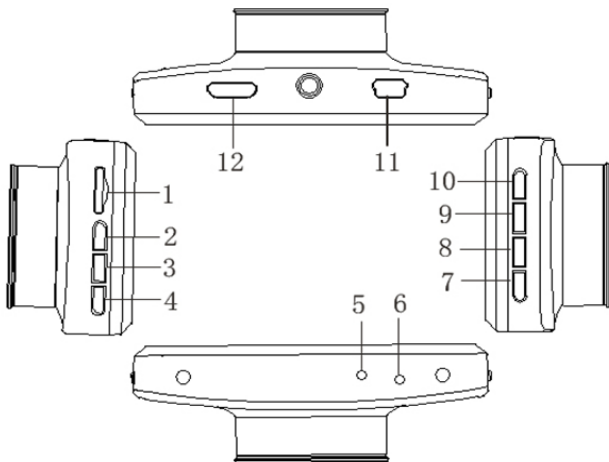











- | | |
|------------------------|--------------------------------|
| 1. Micro Sd Card Slot | 07. Right Arrow (Scroll) |
| 2. UP Arrow (Scroll) | 08. Manual Lock Button |
| 3. Menu Button | 09. Mode Change Button |
| 4. Down Arrow (Scroll) | 10. Ok Button (Stop/Rec/Enter) |
| 5. Mic | 11. DC Power input |
| 6. Reset | 12. HDMI Slot |



Buttons

Button	Functions
	Press and hold to turn the device on or off. Hot Keys during recording mode: <ul style="list-style-type: none">Press to manual turn off / on LCD screen when recording.
OK	Press to start or stop recording. The OK button also acts as an OK button to confirm your selection in setting mode.
MENU 	Press  to enter and exit Setting mode
▲UP ▼Down	Press to navigate to the preferred functions required during Setting. Hot Keys during recording mode: <ul style="list-style-type: none">Up – Press to mute/ unmute the microphone during recording.
MODE (“M”)	Press “M” for to toggle between Recording/Photo/Playback mode
RESET	Press and hold for more than 3 seconds to reset the device if it has fatal errors or hang-ups, or freezes.

Status Icons

Icon	Meaning
	Video Resolution set to Full HD1080P (1920X1080) 16:9
	Charging via USB Charger
	Battery Power Level
	Microphone Mute (unmute icon will not appear)
	Video Recording Mode
	Video Playback Mode
	Photo Mode
	Motion detect
	Loop Recording
	G Sensor Activate
	Memory Card Inserted
	White Balance Status

Package contents

Check the product box for the following items:

- TX1 Front Camera
- Operating Manual
- Mounting holder for camera (3M Stick / Suction Type)
- Car Charger (5V output type)

The items supplied with the device and any available accessories may vary depending on the region. The supplied items are designed only for this device and may not be compatible with other devices.

Appearances and specifications are subject to change without prior notice. Malfunctions caused by using unapproved accessories are not covered by the warranty service. Availability of all accessories is subject to change depending entirely on manufacturing companies. For more information about available accessories, refer to the Maka GPS Technologies Group website.

Installation

1 Fixing the camera to the window mount

It is compulsory for window mount to be fixed up before using the device in a car. Make sure that you place the recorder in an appropriate place, so as not to obstruct the driver's view.

2 Connecting charger to the Power Port

Connect only the manufacturer-approved charger supplied with your device. Use only Maka GPS Technologies Group-approved charger specifically designed for your device. Incompatible charger can cause serious injuries or damage to your device.

3 Inserting a memory card

You have to insert a memory card before you can start recording. The recorder supports Micro SD cards with up to 64GB capacity. You are advised to use a Class 10 memory card with at least 8GB capacity. DO NOT insert or remove the memory card when operating the device.

Charging the battery

Use the charger to charge the battery before using it for the first time. Charge the device by connecting front camera via the USB car charger. Use only Maka-approved chargers, batteries, and cables. Unapproved chargers or cables can cause the battery to explode or damage the device.

Connect the Micro USB car charger to a charging port output that support 12V to 24V.

- When device detects no power supply, it will automatically switch off in 5 seconds time. To turn on the device again, you will need to press on the  on/ off button to manually switch it on.
- If the battery is completely discharged, the device cannot be turned on immediately when the charger is connected. Allow a depleted battery to charge for a few minutes before turning on the device.

Connecting the charger improperly may cause serious damage to the device. Any damage caused by misuse is not covered by the warranty.

- The device can be used while it is charging, but it may take longer to fully charge the battery.
- While charging, the device may heat up. This is normal and should not affect the device's lifespan or performance.
- If the device is not charging properly, take the device and the charger to a Maka Service Centre.

Inserting a memory card

Your device accepts memory cards with maximum capacities of 64 GB. Depending on the memory card manufacturer and type, some memory cards may not be compatible with your device.

Some memory cards may not be fully compatible with the device. Using an incompatible card may damage the device or the memory card, or corrupt the data stored in it.

Use caution to insert the memory card right-side up as shown in the image below.

- Insert a memory card with the gold-coloured contacts facing downwards.
- Push the memory card into the slot until it locks in place.



It is recommended to reformat a memory card every time images are transferred from it to a computer, or at least once every 2 weeks.

Reformatting a memory card keeps data and the structure of files stored on it clean, helping to prevent error messages and missing images. Reformatting also restores the memory card, which can prevent it from becoming corrupted.

Removing the memory card

Before removing the memory card, first unmounts it for safe removal.

On the device

- 1 Press on the **OK** button to stop the device from recording (Blue light will stop blinking).
- 2 Press on the  **ON/OFF** button for 2 to 3sec to switch off the device
- 3 Remove the Micro SD memory card from the slot.

Do not remove the memory card while the device is transferring or accessing information. Doing so can cause data to be lost or corrupted or damage to the memory card or device. Maka GPS Technologies Group is not responsible for losses that result from the misuse of damaged memory cards, including the loss of data.

Formatting the memory card

You may choose to format your memory card on a computer or on the device.

Before formatting the memory card, remember to make backup copies of all important data stored on the device. The manufacturer's warranty does not cover loss of data resulting from user actions.

Turning the device on and off

Press and hold the Power button for a few seconds to turn on the device. A welcome message will be displayed on screen as shown in the image below.



To turn off the device, press and hold the Power button for a few seconds again to turn off the device. A goodbye message will be displayed on screen as shown in the image below.





Note : TX1 FHD Digital Roadcorder™ will be switch on and off automatically if you have permanently connected it to the car charger.

VIDEO/SYSTEM SETTING

Access the following settings to change the device's video recording quality. The better the quality, the higher the capacity of the sd card used is higher.

Resolution



- 1 Press **OK** to stop recording.
- 2 Press  once to enter into video setting
- 3 Press on **Up** or **Down** button to navigate to the function that shows **Resolution**
- 4 Press on **OK** to enter showing **1920x1080 30P** or **1280x720 30P etc**
- 5 Press on the **Up** or **Down** button to make your selection
- 6 Press on **OK** to confirm your entry and exit to setting
- 7 Press on  **button twice** to exit Setting and back recording mode
- 8 Start recording by pressing **OK** button
- 9 Stop recording by pressing **OK** button again

Loop Recording

The device will continue to record by erasing the previously recorded oldest video. All old videos will be replaced with the new ones.

It is recommended to reformat a memory card every time images are transferred from it to a computer, or at least once every 2 week to keep data and the structure of files stored on it clean, helping to prevent error messages and missing images.

It is important to make backup copies of all important data stored on the device. The manufacturer's warranty does not cover loss of data resulting from user actions.

- 1 Press **OK to stop recording.**
- 2 Press  once to enter into video setting
- 3 Press on **Left** or **Right** button to navigate to the function that shows **Loop Recording**
- 4 Press on **OK to enter for next selection : off/ 1min/3min/5min.**
- 5 Press on the **Up** or **Down** button to make your selection
- 6 Press on **OK** to confirm your entry and exit to setting
- 7 Press on  **button twice** to exit Setting and back recording mode
- 8 Start recording by pressing **OK** button
- 9 Stop recording by pressing **OK** button again

HDR (High Dynamic Range)



This function enables you to have a better recording quality when it comes to over brightness or lowly dim lighting which it will provide you a balance lighting exposure to have a clearer recording view.

- 1 Press **OK to stop recording.**
- 2 Press  once to enter into video setting
- 3 Press on **Up** or **Down** button to navigate to the function that shows **HDR**
- 4 Press on **OK to enter for next selection : Off / On.**

- 5 Press on the **Up** or **Down** button to make your selection
- 6 Press on **OK** to confirm your entry and exit to setting
- 7 Press on  **button twice** to exit Setting and back recording mode
- 8 Start recording by pressing **OK** button
- 9 Stop recording by pressing **OK** button again



Motion Detector

This function enables you to use your device as a remote surveillance camera with motion detection functionality. It uses the built-in camera to detect movements in the surrounding area using an advanced motion detection algorithm. Camera will auto record if it detects any movement.

- 1 Press **OK to stop recording.**
- 2 Press  once to enter into video setting
- 3 Press on **Up** or **Down** button to navigate to the function that shows **Motion Detection**
- 4 Press on **OK to enter and show : OFF/ ON**
- 5 Press on the **Up** or **Down** button to make your selection
- 6 Press on **OK** to confirm your entry and exit to setting
- 7 Press on  **button twice** to exit Setting and back recording mode
- 8 Start recording by pressing **OK** button
- 9 Stop recording by pressing **OK** button again

Record Audio

You may choose to turn off the microphone so that all the recorded videos will be muted.

- 1 Press **OK to stop recording.**
- 2 Press  once to enter into video setting
- 3 Press on **Up** or **Down** button to navigate to the function that shows **Record Audio**
- 4 Press on **OK to enter for next selection : Off / On.**
- 5 Press on the **Up** or **Down** button to make your selection
- 6 Press on **OK** to confirm your entry and exit to setting
- 7 Press on  **button twice** to exit Setting and back recording mode
- 8 Start recording by pressing **OK** button
- 9 Stop recording by pressing **OK** button again

Alternatively, you can choose using the hot keys for shortcuts



Hot Keys during recording mode:

- Press on UP button – Press to mute / unmute the microphone during recording. During mute, icon  will appear on the screen.

Date Stamp



You have an option to display your time and date in your videos. Date and Time stamp will not be able to remove once you have activated this feature.

- 1 Press **OK to stop recording.**

2. Press  once to enter into video setting
3. Press on **Up** or **Down** button to navigate to the function that shows **Date Stamp**
4. Press on **OK to enter and see : ON/OFF**
5. Press on the **Up** or **Down** button to make your selection
6. Press on **OK** to confirm your entry and exit to setting
7. Press on  **button twice** to exit Setting and back recording mode
8. Start recording by pressing **OK** button
9. Stop recording by pressing **OK** button again

Gravity Sensor

This function acts like an accelerometer. It measures the acceleration and gravity forces detected on the camera. At such case during recording, the device will auto do a file lock. We recommend you to set [low]

1. Press **OK to stop recording.**
2. Press  once to enter into video setting
3. Press on **Up** or **Down** button to navigate to the function that shows **Gsensor**
4. Press on **OK to enter and see : Off / Low / Medium / High**
5. Press on the **Up** or **Down** button to make your selection
6. Press on **OK** to confirm your entry and exit to setting
7. Press on  **button twice** to exit Setting and back recording mode
8. Start recording by pressing **OK** button
9. Stop recording by pressing **OK** button again

Date/ Time Setup

Access the following settings to change the device's time and date.



If the battery remains fully discharged or removed from the device, the time and date is reset.

- 1 Press **OK to stop recording.**
- 2 Press  once to enter into video setting
- 3 Press on **Up** or **Down** button to navigate to the function that shows **Date / Time**
- 4 Press on **OK to enter and see in : YY/MM/DD**
- 5 Press on the **Up** or **Down** button to make your selection
- 6 Press on **OK** to confirm and next entry made follow by exit setting and back to recording mode
- 7 Start recording by pressing **OK** button
- 8 Stop recording by pressing **OK** button again

Car No Stamp



This function enable you to enter car plate number of your own vehicle for video recording information.

- 1 Press **OK to stop recording.**
- 2 Press  once to enter into video setting
- 3 Press on **Up** or **Down** button to navigate to the function that shows **Car No Stamp**
- 4 Press on **OK to enter and show : Off / On**
- 5 Press on the **Up** or **Down** button to make your selection

- 6 Press on **OK (if selection On)** to confirm your entry and enter to set the number plate
- 7 Press on the **Up** or **Down** button to make your selection and **OK button** to make the next entry
- 8 Press on  **button Once** to exit Setting once last entry made
- 9 Press on  **button Once** again to exit Setting and back recording mode
- 10 Start recording by pressing **OK** button
- 11 Stop recording by pressing **OK** button again



Auto Power Off

This function enable you to select the auto shut down of the device if the unit is not in the recording mode which help to alert driver.

- 1 Press **OK to stop recording.**
2. Press  once to enter into video setting
- 3 Press on **Up** or **Down** button to navigate to the function that shows **Auto Power Off**
- 4 Press on **OK to enter and show : OFF/ 1min/ 3min / 5min/ 10min**
- 5 Press on the **Up** or **Down** button to make your selection
- 6 Press on **OK** to confirm your entry and exit to setting
- 7 Press on  **button once** to exit Setting and back recording mode
- 8 Start recording by pressing **OK** button
- 9 Stop recording by pressing **OK** button again



Beep Sound

This function is to turn on/off of the the button sound.

- 1 Press **OK to stop recording.**
- 2 Press  once to enter into video setting
- 3 Press on **Up** or **Down** button to navigate to the function that shows **Beep Sound**
- 4 Press on **OK to enter and see : Off / On**
- 5 Press on the **Up** or **Down** button to make your selection
- 6 Press on **OK** to confirm your entry and exit to setting
- 7 Press on  **button once** to exit Setting and back recording mode
- 8 Start recording by pressing **OK** button
- 9 Stop recording by pressing **OK** button again

Language



The available language may vary depending on the region.

- 1 Press **OK to stop recording.**
- 2 Press  once to enter into video setting
- 3 Press on **Up** or **Down** button to navigate to the function that shows **Language**
- 4 Press on **OK to enter and see : English etc.**
- 5 Press on the **Up** or **Down** button to make your selection
- 6 Press on **OK** to confirm your entry and exit to setting
- 7 Press on  **button once** to exit Setting and back recording mode

- 8 Start recording by pressing **OK** button
- 9 Stop recording by pressing **OK** button again

Frequency

Please set according to the local power supply respectively; 50Hz or 60Hz.

- 1 Press **OK to stop recording.**
2. Press  once to enter into video setting
- 3 Press on **Up** or **Down** button to navigate to the function that shows **LIGHT FREQ.**
- 4 Press on **OK to enter and show : 50Hz/ 60Hz**
- 5 Press on the **Up** or **Down** button to make your selection
- 6 Press on **OK** to confirm your entry and exit to setting
- 7 Press on  **button once** to exit Setting and back recording mode
- 8 Start recording by pressing **OK** button
- 9 Stop recording by pressing **OK** button again

LCD Display (Screen Saver)

Select timer duration for the LCD to turn off after recording starts.

- 1 Press **OK to stop recording.**
2. Press  once to enter into video setting
- 3 Press on **Up** or **Down** button to navigate to the function that shows **LCD Time Out**
- 4 Press on **OK to enter and show : OFF/ 30sec/ 1min/ 3min**
- 5 Press on the **Up** or **Down** button to make your selection

- 6 Press on **OK** to confirm your entry and exit to setting
- 7 Press on  **button once** to exit Setting and back recording mode
- 8 Start recording by pressing **OK** button
- 9 Stop recording by pressing **OK** button again



Alternatively, you can choose using the hot keys for shortcuts

Hot Keys during recording mode:



- Press on  button – Press to manual turn off / turn back on when off mode during recording time.

Exposure

Adjust exposure according to your preference. Default setting is set as +0.0 and recommended not to change unless changes made on your preference liking.

- 1 Press **OK to stop recording.**
- 2 Press  once to enter into video setting
- 3 Press on **Up** or **Down** button to navigate to the function that shows **Exposure**
- 4 Press on **OK to enter and show : +0.0/ +1/3 or -1/3 etc**
- 5 Press on the **Up** or **Down** button to make your selection
- 6 Press on **OK** to confirm your entry and exit to setting
- 7 Press on  **button once** to exit Setting and back recording mode
- 8 Start recording by pressing **OK** button
- 9 Stop recording by pressing **OK** button again

Anti-Shaking

- 1 Press **OK to stop recording.**
- 2 Press  once to enter into video setting
- 3 Press on **Up** or **Down** button to navigate to the function that shows **Anti-Shaking**
- 4 Press on **OK to enter and show : Off/ On**
- 5 Press on the **Up** or **Down** button to make your selection
- 6 Press on **OK** to confirm your entry and exit to setting
- 7 Press on  **button once** to exit Setting and back recording mode
- 8 Start recording by pressing **OK** button
- 9 Stop recording by pressing **OK** button again

Note ; This function is only used on photo taking and not applicable to video recording.

Delay Shutdown

This function will allow the device to shut down after the set timer when the engine is off

- 1 Press **OK to stop recording.**
- 2 Press  once to enter into video setting
- 3 Press on **Up** or **Down** button to navigate to the function that shows **Delay Shutdown**
- 4 Press on **OK to enter and show : 15sec/30sec/1min/5min**
- 5 Press on the **Up** or **Down** button to make your selection

- 6 Press on **OK** to confirm your entry and exit to setting
- 7 Press on  **button once** to exit Setting and back recording mode
- 8 Start recording by pressing **OK** button
- 9 Stop recording by pressing **OK** button again

Format



This function allows device to format the Micro Sd card. Recommended to format the card once every 2 week.

- 1 Press **OK to stop recording.**
2. Press  once to enter into video setting
- 3 Press on **Up** or **Down** button to navigate to the function that shows **FORMAT**
- 4 Press **OK** and enter showing **Cancel** or **OK**.
- 5 Press on the **Up** or **Down** button to make your selection

- 6 Press on **OK** to confirm your entry and exit to setting
- 7 Press on  **button once** to exit Setting and back recording mode
- 8 Start recording by pressing **OK** button
- 9 Stop recording by pressing **OK** button again

Restore Factory Setting (Default Setting)

Set the system parameters to the default value of the device origin install at. By doing so, any setting which needed to change accordingly to user preference will have to set the setting again.

- 1 Press **OK to stop recording.**
- 2 Press  once to enter into video setting
- 3 Press on **Up** or **Down** button to navigate to the function that shows **DEFAULT SET**
- 4 Press on **OK**
- 5 Press on the **Up** or **Down** button to make your selection
- 6 Press on **OK** to confirm your entry and exit to setting
- 7 Press on  **button once** to exit Setting and back recording mode
- 8 Start recording by pressing **OK** button
- 9 Stop recording by pressing **OK** button again

Version



The function allow you to view the version of the firmware and any available version update will be release accordingly if there is.

Version : TX1 XXXXXXXX

PHOTO SETTING

Capture Mode

This setting allowed you to set pre-time the photo delay being taken when pressing the shot button

- 1 Press **M button once** enter into Photo Mode
- 2 Press on Menu  once to enter Photo Setting
- 3 Press on **Up** or **Down** button to navigate to the function that shows Resolution
- 4 Press on **OK to enter showing Single/ 2S/ 5S/ 10S**
- 5 Press on the **Up** or **Down** button to make your selection
- 6 Press on **OK** to confirm your entry and exit to photo setting
- 7 Press on Menu  twice to exit Setting
- 8 Press **OK** button for photo shooting

Resolution



This function enabled to change the picture quality taking.

- 1 Press **M button once** enter into Photo Mode
- 2 Press on Menu  once to enter Photo Setting
- 3 Press on **Up** or **Down** button to navigate to the function that shows Resolution
- 4 Press on **OK to enter showing 12M,10M, 8M,5M, etc**
- 5 Press on the **Up** or **Down** button to make your selection

- 6 Press on **OK** to confirm your entry and exit out to photo setting
- 7 Press **OK** button for photo shooting

Sequence

This function enable shooting of 3 photo in one single shot.

- 1 Press **M button once** enter into Photo Mode
- 2 Press on Menu  once to enter Photo Setting
- 3 Press on **Up** or **Down** button to navigate to the function that shows **Sequence**
- 4 Press on **OK to enter showing ON/OFF**
- 5 Press on the **Up** or **Down** button to make your selection
- 6 Press on **OK** to confirm your entry and exit to photo setting
- 7 Press on Menu  twice to exit Setting
- 8 Press **OK** button for photo shooting

Quality



This function enabled to set the quality of the photo to be taken.
The lower the quality, the memory taken will be lesser.

- 1 Press **M button once** enter into Photo Mode
- 2 Press on Menu  once to enter Photo Setting
- 3 Press on **Up** or **Down** button to navigate to the function that shows **Quality**
- 4 Press on **OK to enter showing FINE/NORMAL/ECOMONY**

- 5 Press on the **Left** or **Right** button to make your selection
- 6 Press on **OK** to confirm your entry and exit to photo setting
- 7 Press on **M** twice to exit Setting
- 8 Press **OK** button for photo shooting

Sharpness

This function enabled to select the photo taking to be more distinctive or clearer picture during photo shooting.

- 1 Press **M button once** enter into Photo Mode
- 2 Press on Menu  once to enter Photo Setting
- 3 Press on **Up** or **Down** button to navigate to the function that shows **Sharpness**
- 4 Press on **OK to enter showing STRONG/NORMAL/SOFT**
- 5 Press on the **Up** or **Down** button to make your selection
- 6 Press on **OK** to confirm your entry and exit to photo setting
- 7 Press on Menu  twice to exit Setting
- 8 Press **OK** button for photo shooting

White Balance



This function enabled to select the balancing of the lighting effect on different environment. Recommended to be set as **(AUTO)**

- 1 Press and hold on **M button for 2 to 3sec** into Photo Mode
- 2 Press on **M** once to enter Photo Setting

- 3 Press on **Left** or **Right** button to navigate to the function that shows **White Balance**
- 4 Press on **OK** to enter showing **AUTO/DAYLIGHT/CLOUDY/TUNGSTEN/FLUORESCENT**
- 5 Press on the **Left** or **Right** button to make your selection
- 6 Press on **OK** to confirm your entry and exit to photo setting
- 7 Press on **M** twice to exit Setting
- 8 Press **OK** button for photo shooting



Color

This function enable to set the effect of the photo taken



- 1 Press **M** button **once** enter into Photo Mode
- 2 Press on Menu  once to enter Photo Setting
- 3 Press on **Up** or **Down** button to navigate to the function that shows **Color**
- 4 Press on **OK** to enter showing **Color/Black & White/Sepia**
- 5 Press on the **Up** or **Down** button to make your selection
- 6 Press on **OK** to confirm your entry and exit to photo setting
- 7 Press on Menu  twice to exit Setting
- 8 Press **OK** button for photo shooting

ISO

This function enabled to set the light sensitivity of the photo to be taken.
Recommended to use as **(AUTO)**

- 1 Press **M button once** enter into Photo Mode
- 2 Press on Menu  once to enter Photo Setting
- 3 Press on **Up** or **Down** button to navigate to the function that shows **ISO**
- 4 Press on **OK to enter showing 100/200//AUTO**
- 5 Press on the **Up** or **Down** button to make your selection
- 6 Press on **OK** to confirm your entry and exit to photo setting
- 7 Press on Menu  twice to exit Setting
- 8 Press **OK** button for photo shooting

Date Stamp

- 1 Press **M button once** enter into Photo Mode
- 2 Press on Menu  once to enter Photo Setting
- 3 Press on **Up** or **Down** button to navigate to the function that shows **Date Stamp**
- 4 Press on **OK to enter showing : OFF/Date/Date & Time**
- 5 Press on the **Up** or **Down** button to make your selection
- 6 Press on **OK** to confirm your entry and exit to photo setting
- 7 Press on Menu  twice to exit Setting
- 8 Press **OK** button for photo shooting

Playback Mode (Video)

- 1 Stop recording by pressing on the **OK** button
- 2 Press **M button twice** to enter into playback Mode
- 3 Press on the **Up** or **Down** button to navigate thru the video files 
- 5 Press on **OK** again to **START** playing
- 6 Press on **OK** again to **PAUSE** playing
- 8 **FAST FORWARD**: Press and hold the **UP** button to forward your video to **2X / 4X / 8X** speed mode.
- 9 **REWIND** : Press the **Down** button to slow forward your video to **-2 X / -4 X / -8 X** speed mode.
- 10 Press **M** button to return back to recording mode

Playback Mode (Photo)

- 1 Stop recording by pressing on the **OK** button
- 2 Press **M button twice** to enter into playback Mode
- 3 Press on the **Up** or **Down** button to navigate thru the photo files 
- 4 Press **M** button to return back to recording mode once photo view done.

Delete / Protect Files

To delete, protect for one or all file

- 1 Stop recording by pressing on the **OK** button
- 2 Press **M button twice** to change from recording to playback mode
- 3 Press **UP** or **Down** button to navigate thru the files.
- 5 Press on Menu  to enter setting
- 6 Press on **UP or Down button** to make a selection Delete / Protect
- 7 Press on **OK** button once if select Delete or Protect
- 8 Delete selection selected next show (Delete Current / Delete All). If Protect selection selected will show (Lock Current/ Unlock Current/ Lock All / Unlock All).
- 9 Make a selection and press **OK button** to enter for confirmation of selection.
- 10 Press on **Left or Right button to make a confirmation selection and exit to playback mode.**
11. Press **M button to change mode back to recording mode.**

Question	Reason	Solution
The captured image is not stored	<ol style="list-style-type: none"> 1 MicroSD card might be full or malfunction. 2 Image is not saved before the power outage. 	<p>Reformat the card or replace a new MicroSD</p> <p>Make sure to stop recording before shutting down.</p>
All buttons are invalid	<ol style="list-style-type: none"> 1 Procedural error or faulty Operation 2 MicroSD Card might be error or faulty 	<p>Press RESET button to restart the DVR.</p> <p>Change a new Sd card or reformat the card</p>
Device cannot be turn on	Device might be low in battery.	Charge the Battery.
Screen Auto power-off	<ol style="list-style-type: none"> 1 Screen Saver function is enabled. 2 Low Battery. 	<ol style="list-style-type: none"> 1 Press on UP button disable the screen saver mode. 2 Charge the battery
Unable to record videos	<ol style="list-style-type: none"> 1 Memory card might be full. 2 If loop recording has been enabled, memory card might be corrupted. 	<ol style="list-style-type: none"> 1 Check your memory card's space. Delete files if required. 2 Reformat your Memory card , if issue still persists, replace a new memory Card
Auto stop recording in video mode	Use a compatible SDHC microSD card for HD video recording.	Get a microSD card that has minimum 8GB Class 10 speed.
Encounter "file error" when trying to playback pictures or videos	MicroSD card might be corrupted. There bad sectors in the card.	Reformat the memory card.

Question	Reason	Solution
No image is displayed on a high-definition TV screen	1 Cable plug might not be plugged in properly. 2 Wrong TV Input mode	1 Ensure AV/HDMI cable is plug into the TV properly. 2 Refer to the back panel of your TV to Track the correct TV input. Make sure you have selected the correct input.
Hazy Images	Lens might be dirty.	Check if there are fingerprints or dust on the lens. Clean it with a micro fabric cloth if necessary.
There are horizontal stripes interference on the image	This could be due to wrong light frequency setting	Please set according to the local power supply respectively;50Hz or 60Hz. For SG/MY:50hz
No image is displayed on a high-definition TV screen	1 Cable plug might not be plugged in properly. 2 Wrong TV Input mode	1 Ensure AV/HDMI cable is plug into the TV properly. 2 Refer to the back panel of your TV to track the correct TV input. Make sure you have selected the correct input.