

Morbella

LXI



USER MANUAL

Trademarks

All brand and product names are trademarks or registered trademarks of Maka GPS Technologies Group. In association with Maka GPS Technologies Private Limited (Singapore), Maka GPS Technologies Sdn. Bhd. (Malaysia), Maka Technologies Group (H.K.) Limited. and Maka Corporation USA Inc.

The information in this manual is subject to change without notice.

www.makagps.com

8/2016. R1.1



Safety information

To prevent injury to yourself and others or damage to your device, read the safety information about your device before using the device.



Warning

Failure to comply with safety warnings and regulations can cause serious injury or death.

Do not use damaged power cords or plugs, or loose electrical sockets

Unsecured connections can cause electric shock or fire.

Do not touch the car charger with wet hands or disconnect the charger by pulling the cord

Doing so may result in electrocution.

Do not bend or damage the car charger

Doing so may cause electric shock or fire.

Do not use your device while it is charging or touch your device with wet hands

Doing so may cause electric shock.

Do not short-circuit the charger or the device

Doing so may cause electric shock or fire, or the battery may malfunction or explode.



Use manufacturer-approved batteries, chargers, accessories, and supplies

- Using generic batteries or chargers may shorten the life of your device or cause the device to malfunction. They may also cause a fire or cause the battery to explode.
- Use only Maka GPS Technologies Group-approved battery and charger specifically designed for your device. Incompatible battery and charger can cause serious injuries or damage to your device.
- Maka GPS Technologies Group cannot be responsible for the user's safety when using accessories or supplies that are not approved by Maka GPS Technologies Group.

Do not drop or cause an impact to the charger or the device.

Handle and dispose of the device and charger with care

- Never dispose of the battery or device in a fire. Never place the battery or device on or in heating devices, such as microwave ovens, stoves, or radiators. The device may explode when overheated. Follow all local regulations when disposing of used battery or device.
- Never crush or puncture the device.
- Avoid exposing the device to high external pressure, which can lead to an internal short circuit and overheating.

Protect the device, battery and charger from damage

- Avoid exposing your device and battery to very cold or very hot temperatures.

Morbella

- Extreme temperatures can damage the device and reduce the charging capacity and life of your device and battery.
- Prevent the battery from coming into contact with metal objects, as this can create a connection between the + and – terminals of your battery and lead to temporary or permanent battery damage.
- Never use a damaged charger or battery.

Do not bite or suck the device or the battery

- Doing so may damage the device or result in an explosion or fire. • Children or animals can choke on small parts.
- If children use the device, make sure that they use the device properly.

Do not handle a damaged or leaking Lithium Ion (Li-Ion) battery

For safe disposal of your Li-Ion battery, contact your nearest authorised service centre



Caution

Failure to comply with safety cautions and regulations can cause injury or property damage

Do not use your device near other electronic devices

Most electronic devices use radio frequency signals. Your device may interfere with other electronic devices.

Do not expose the device to heavy smoke or fumes

Doing so may damage the outside of the device or cause it to malfunction.

Do not use your device near devices or apparatuses that emit radio frequencies, such as sound systems or radio towers

Radio frequencies may cause your device to malfunction.

If you notice strange smells or sounds coming from your device or the battery, or if you see smoke or liquids leaking from the device or battery, stop using the device immediately and take it to a Maka Service Centre

Failure to do so may result in fire or explosion.

For your own safety, do not operate the controls of the product while driving.

Two window mounts are needed when using the recorder in a car. Make sure that you place the recorder in an appropriate place, so as not to obstruct the driver's view.

Make sure that no object is blocking the camera lens and no reflective material appears near the lens.

Please keep the lens clean. If the car's windscreen is tinted with a dark solar film coating, it may affect the recording quality.

Morbella

Do not store your device in very hot or very cold areas. It is recommended to use your device at temperatures from 0 °C to 60 °C and humidity from 10% to 80%

Doing so may cause the screen to malfunction, result in damage to the device, or cause the battery to explode.

Do not use your device or applications for a while if the device is overheated

Prolonged exposure of your skin to an overheated device may cause low temperature burn symptoms, such as red spots and pigmentation.

Install mobile devices and equipment with caution

- Ensure that any mobile devices or related equipment installed in your vehicle are securely mounted.
- Avoid placing your device and accessories near or in an airbag deployment area. Improperly installed wired equipment can cause serious injury when airbags inflate rapidly.

Do not drop your device or cause impacts to your device

- Your device may be damaged or may malfunction.
- If bent or deformed, your device may be damaged or parts may malfunction.

Ensure maximum battery and charger life

- Avoid charging your device for more than a week, as overcharging may shorten battery life.
- Over time, unused device will discharge and must be recharged before use.
- Disconnect the charger from power sources when not in use.

Morbella

- Leaving batteries unused over time may reduce their lifespan and performance. It may also cause the batteries to malfunction or explode, or cause a fire.
- Your device may wear out over time. Some parts and repairs are covered by the warranty within the validity period, but damages or deterioration caused by using unapproved accessories are not.

Do not disassemble, modify, or repair your device

- Any changes or modifications to your device can void your manufacturer's warranty. If your device needs servicing, take your device to a Maka Service Centre.
- Do not disassemble or puncture the battery, as this can cause explosion or fire.
- Turn off the device before removing the battery. If you remove the battery with the device turned on, it may cause the device to malfunction.

When cleaning your device, mind the following

- Wipe your device or charger with a towel or an eraser.
- Do not use chemicals or detergents. Doing so may discolour or corrode the outside the device or may result in electric shock or fire.

Do not distribute copyright-protected material

Do not distribute copyright-protected material without the permission of the content owners. Doing this may violate copyright laws. The manufacturer is not liable for any legal issues caused by the user's illegal use of copyrighted material.

Correct disposal of this product



(Waste Electrical & Electronic Equipment)

(Applicable in countries with separate collection systems)

This marking on the product, accessories or literature indicates that the product and its electronic accessories (e.g. charger, headset, USB cable) should not be disposed of with other household waste.

To prevent possible harm to the environment or human health from uncontrolled waste disposal, please separate these items from other types of waste and recycle them responsibly to promote the sustainable reuse of material resources.

Household users should contact either the retailer where they purchased this product, or their local government office, for details of where and how they can take these items for environmentally safe recycling.

Business users should contact their supplier and check the terms and conditions of the purchase contract. This product and its electronic accessories should not be mixed with other commercial wastes for disposal.



Disclaimer

Some content and services accessible through this device belong to third parties and are protected by copyright, patent, trademark and/or other intellectual property laws. Such content and services are provided solely for your personal non-commercial use.

You may not use any content or services in a manner that has not been authorised by the content owner or service provider. Without limiting the foregoing, unless expressly authorised by the applicable content owner or service provider, you may not modify, copy, republish, upload, post, transmit, translate, sell, create derivative works, exploit, or distribute in any manner or medium any content or services displayed through this device.

"THIRD PARTY CONTENT AND SERVICES ARE PROVIDED "AS IS." MAKI GPS TECHNOLOGIES GROUP DOES NOT WARRANT CONTENT OR SERVICES SO PROVIDED, EITHER EXPRESSLY OR IMPLIEDLY, FOR ANY PURPOSE. MAKI EXPRESSLY DISCLAIMS ANY IMPLIED WARRANTIES, INCLUDING BUT NOT LIMITED TO, WARRANTIES OF MERCHANTABILITY OR FITNESS FOR A PARTICULAR PURPOSE. MAKI GPS TECHNOLOGIES GROUP DOES NOT GUARANTEE THE ACCURACY, VALIDITY, TIMELINESS, LEGALITY, OR COMPLETENESS OF ANY CONTENT OR SERVICE MADE AVAILABLE THROUGH THIS DEVICE AND UNDER NO CIRCUMSTANCES, INCLUDING NEGLIGENCE, SHALL MAKI GPS TECHNOLOGIES GROUP BE LIABLE, WHETHER IN CONTRACT OR TORT, FOR ANY DIRECT, INDIRECT, INCIDENTAL, SPECIAL OR CONSEQUENTIAL DAMAGES, ATTORNEY FEES, EXPENSES, OR ANY OTHER DAMAGES ARISING OUT OF, OR IN CONNECTION WITH, ANY INFORMATION CONTAINED IN, OR AS A RESULT OF THE USE OF ANY CONTENT OR SERVICE BY YOU OR ANY THIRD PARTY, EVEN IF ADVISED OF THE POSSIBILITY OF SUCH DAMAGES."



Third party services may be terminated or interrupted at any time, and Maka GPS Technologies Group makes no representation or warranty that any content or service will remain available for any period of time. Content and services are transmitted by third parties by means of networks and transmission facilities over which Maka GPS Technologies Group has no control. Without limiting the generality of this disclaimer, Maka GPS Technologies Group expressly disclaims any responsibility or liability for any interruption or suspension of any content or service made available through this device.

Maka GPS Technologies Group is neither responsible nor liable for customer service related to the content and services. Any question or request for service relating to the content or services should be made directly to the respective content and service providers.



About this manual

This device provides high quality digital recording device using Maka's high standards and technological expertise. This user manual is specially designed to detail the device's functions and features.

- Please read this manual before using the device to ensure safe and proper use. Descriptions are based on the device's default settings.
- Images and screenshots may differ in appearance from the actual product.
- Content may differ from the final product, or from software provided by service providers and is subject to change without prior notice.
- For the latest version of the manual, refer to the Maka website at www.makagps.com.
- Available features and additional services may vary by device, software.
- Applications and their functions may vary by country, region, or hardware specifications.
- Maka is not liable for performance issues caused by applications from any provider other than Maka.
- Maka is not liable for performance issues or incompatibilities caused by not installing the device as stated in this manual. Attempting to customise the installation may cause the device or applications to work improperly. This may result in device malfunctions and data corruption or loss. These actions are violations of your Maka agreement and will void your warranty.
- Default applications that come with the device are subject to updates and may no longer be supported without prior notice. If you have questions about an application provided with the device, contact Maka Service Centre.



Table of Contents

Product Specifications	14
Getting Started	
Overview of your LX1 FHD Digital Roadcorder™	
Device Layout	15
Understanding of your LX1 FHD Digital Roadcorder™	
Buttons	16
Status Icons	17
Standard Packaging of your LX1 FHD Digital Roadcorder™	
Package Contents	18
Installation of your LX1 FHD Digital Roadcorder™	
Installation	19
Charging the Battery	20
Inserting Memory Card	21
Removing Memory Card	22
Formatting Memory Card	23
Turning the device on and off	24
Operation of your LX1 FHD Digital Roadcorder™	
<u>VIDEO SETTING</u>	
Video Resolution	25
Loop Recording	25-26
White Balance	26
Exposure	27
Auto Record	27
Date/Time Watermark	28
Motion Detector	28
Plate Number	29

Morbella

SYSTEM SETTING (Video/Photo)

Gravity Sensing (G Sensor)	30
Recording Sound	30-31
Volume	31
Keytone	32
Light Frequency	32
Card Info	33
Formatting	23
Language	33
Date/ Time Setup	34
Screen Switch (Saver)	34
Restore Factory Setting	35
Playback Mode	35
Delete Files	36

PHOTO SETTING

Photo Resolution	36
Photo Compression Quality	37
White Balance	37
Exposure	38
Photo Watermark	38

General Troubleshooting	39-40.
--------------------------------	---------------



Product Specifications





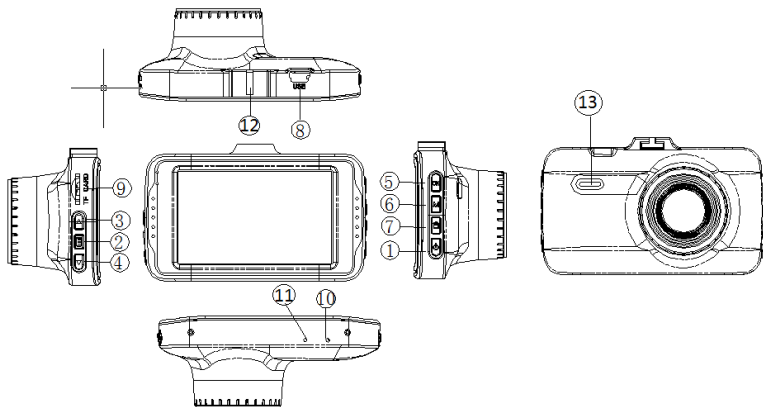

Sensor	3MP CMOS sensors, OV2710
Lens	Fixed focus full glass elements (140°)
Aperture	F=2.2, f=4.48
CPU	All Winner V3S
LCD	3.0 inch 16:9 TFT LCD
Audio	Built-in high sensitivity microphone/speaker
External Memory	Class 10 or above TF card (SDHC specification up to 32G)
Gravity sensor	Sensitivity low/medium/high/Close
Motion detect	ON/OFF
Shutter	Electronic shutter
White balance	Auto
Exposure	Auto ISO
Battery (Internal)	240mAh 3.7V rechargeable lithium battery
Video format	MOV
Video resolution	1920x1080P30, 1280x720P30
Language	English, Traditional/Simplified Chinese, France, Spanish, Portuguese, Deutsch, Italian, Russian Japan
USB	USB 2.0
Loop recording	Close /1min /3 min/5 min
Auto screen off	Close/10 sec/20 sec/ 30 sec
PC Camera	Yes
Microphone mute	ON/OFF

Device Layout













- | | | | |
|---------------------------------|--|----|-------------------------|
| 1 | On/Off Button
(Hotkey : Press once to turn on/off screen) | 7 | Manual Lock File Button |
| 2 | Menu Button | 8 | USB Charging Port |
| 3 | Up Navigation Button | 9 | SD Card Slot |
| (Hotkey : Motion/Normal record) | | 10 | Soft Reset pin hole |
| 4 | Down Navigation Button | 11 | Mic |
| ((Hotey : Mute/Unmute Button) | | 12 | Suction Slot |
| 5 | Enter/Recording Button | 13 | Speaker |
| 6 | Mode Switch Button | | |



Buttons

Button	Functions
	Press and hold to turn the device on or off. Hot Keys during recording mode: <ul style="list-style-type: none">• Press once to turn off/on the LCD screen with continuous recording
	The button acts as a manual lock file during recording.
M	Press M to change the mode from Video -> Photo -> Playback mode
OK	Press OK to start a recording or Enter button when in Setting mode
 UP / DOWN 	Press to navigate to the preferred functions required during Setting. Hot Keys during recording mode: <ul style="list-style-type: none">• UP –Press and hold to switch mode between Motion/Normal recording• DOWN – Press to mute/ unmute the microphone during recording.
	Press  to enter in to Video/System Setting
RESET	Press and release using a fine pin to reset the device if it has fatal errors or hang-ups, or freezes.

Status Icons

Icon	Meaning
	Video Resolution set to Full HD1080P (1920X1080) 16:9
	G Sensor
	Charging via USB Charger
	Battery Power Level
	Microphone Mute
	Microphone On
	Video Recording Mode
	Motion Detect Recording
	Loop Recording with Minutes indication
	SD Card Inserted
	Lock file indication
	Video/Photo Playback Mode
	Photo Shoot Mode

Package contents

Check the product box for the following items:

- LX1 Front Camera
- Operating Manual
- Mounting holder for camera (Suction Mount Type)
- Mounting holder for camera (3M Mount Type)
- USB Cable
- Car Charger

The items supplied with the device and any available accessories may vary depending on the region. The supplied items are designed only for this device and may not be compatible with other devices.

Appearances and specifications are subject to change without prior notice. Malfunctions caused by using unapproved accessories are not covered by the warranty service. Availability of all accessories is subject to change depending entirely on manufacturing companies. For more information about available accessories, refer to the Maka GPS Technologies Group website.

Installation

1 Fixing the camera to the window mount

It is compulsory for window mount to be fixed up before using the device in a car. Make sure that you place the recorder in an appropriate place, so as not to obstruct the driver's view.

2 Connecting charger to the cigarette lighter

Connect only the manufacturer-approved charger supplied with your device. Use only Maka GPS Technologies Group-approved charger specifically designed for your device. Incompatible charger can cause serious injuries or damage to your device.

3 Inserting a memory card

You have to insert a memory card before you can start recording. The recorder supports Micro SD cards with up to 32GB capacity. You are advised to use a Class 10 memory card with at least 8GB capacity. DO NOT insert or remove the memory card when operating the device.

Charging the battery

Use the charger to charge the battery before using it for the first time. Charge the device by connecting front camera via the USB car charger. Use only Maka-approved chargers, batteries, and cables. Unapproved chargers or cables can cause the battery to explode or damage the device.

Connect the USB car charger's jack to the USB charging port and then plug the charger into the car cigarette lighter socket.

- When device detects no power supply, it will automatically switch off in 5 seconds time. To turn on the device again, you will need to press on the  on/ off button to manually switch it on.
- If the battery is completely discharged, the device cannot be turned on immediately when the charger is connected. Allow a depleted battery to charge for a few minutes before turning on the device.

Connecting the charger improperly may cause serious damage to the device. Any damage caused by misuse is not covered by the warranty.

- The device can be used while it is charging, but it may take longer to fully charge the battery.
- If the device receives an unstable power supply while charging, the screen may not function. If this happens, unplug the charger from the device.
- While charging, the device may heat up. This is normal and should not affect the device's lifespan or performance.
- If the device is not charging properly, take the device and the charger to a Maka Service Centre.

Inserting a memory card

Your device accepts memory cards with maximum capacities of 32 GB. Depending on the memory card manufacturer and type, some memory cards may not be compatible with your device.

Some memory cards may not be fully compatible with the device. Using an incompatible card may damage the device or the memory card, or corrupt the data stored in it.

Use caution to insert the memory card right-side up as shown in the image below.

- Insert a memory card with the gold-coloured contacts facing downwards.
- Push the memory card into the slot until it locks in place.



It is recommended to reformat a memory card every time images are transferred from it to a computer, or at least once a month.

Reformatting a memory card keeps data and the structure of files stored on it clean, helping to prevent error messages and missing images. Reformatting also restores the memory card, which can prevent it from becoming corrupted.

Removing the memory card

Before removing the memory card, first unmounts it for safe removal.

On the device



- 1 Press on the **OK** button to stop the device from recording
- 2 Press on the **ON/OFF** button to switch off the device
- 3 Pull out the memory card.

Do not remove the memory card while the device is transferring or accessing information. Doing so can cause data to be lost or corrupted or damage to the memory card or device. Maka GPS Technologies Group is not responsible for losses that result from the misuse of damaged memory cards, including the loss of data.

Formatting the memory card

You may choose to format your memory card on a computer or on the device.

On the device

- 1 Press on **OK** button to stop the device from recording
- 2 Press on the  button twice to enter System Setting
- 3 Press on **DOWN** button to navigate to the function that shows Formatting
- 4 Press on **OK** to enter for selection (Confirmation/Cancel).
- 5 Press on up/down button to select (selection will be in white bold) and **OK** button to confirm your selection on SD Card.
- 6 Press on  once to exit back to the recording screen

Before formatting the memory card, remember to make backup copies of all important data stored on the device. The manufacturer's warranty does not cover loss of data resulting from user actions.

Turning the device on and off

Press and hold the Power button for a few seconds to turn on the device. A welcome message will be displayed on screen as shown in the image below.





To turn off the device, press and hold the Power button for a few seconds again to turn off the device. A goodbye message will be displayed on screen as shown in the image below.



LX1 FHD Digital Roadcorder™ will switch on and off automatically if you have permanently connected it to the car charger.

VIDEO SETTING

Resolution



- 1 Press on  once to enter Video setting()
- 2 Press on **UP** or **DOWN** button to navigate to the function that shows Video Resolution
- 3 Press on **OK** to enter showing **1920x1080 30P** or **1280x720 30P**
- 4 Press on the **UP** or **DOWN** button to make your selection (Tick icon)
- 5 Press on **OK** to confirm your entry and exit to setting
- 6 Press on  twice to exit Setting
- 7 Start recording by pressing **OK** button

Loop Recording

The device will continue to record by erasing the previously recorded videos. All old videos will be replaced with the new ones.



It is recommended to reformat a memory card every time images are transferred from it to a computer, or at least once a month to keep data and the structure of files stored on it clean, helping to prevent error messages and missing images.

It is important to make backup copies of all important data stored on the device. The manufacturer's warranty does not cover loss of data resulting from user actions.

- 1 Press on  once to enter video setting ()
- 2 Press on **UP** or **DOWN** button to navigate to the function that shows **Loop Recording**
- 3 Press on **OK** button to enter for next selection : **Close/1min/2min/5min**
- 4 Press on the **UP** or **DOWN** button to make your selection
- 5 Press on **OK** to confirm your entry and exit to setting
- 6 Press on  twice to exit Setting to recording mode



White Balance

This function enable to select the balancing of the lighting effect on different environment. Recommendation to be set as **(AUTO)**

- 1 Press on  once to enter video setting ()
- 2 Press on **UP** or **DOWN** button to navigate to the function that shows **White Balance**
- 4 Press on **OK** to enter showing:
AUTO/SUNNY/CLOUDY/INCANDESCENT/FLUORESCENT
- 5 Press on the **UP** or **DOWN** button to make your selection
- 6 Press on **OK** to confirm your entry and exit to setting
- 7 Press on  twice to exit Setting and back to recording mode



Exposure

Adjust exposure (Dimmer or brighter) according to your preference on the video to be recorded. Recommended will be neutral set at +0.0 (Default)

- 1 Press on  once to enter video setting()
- 2 Press on **UP** or **DOWN** button to navigate to the function that shows **Exposure**
- 3 Press on **OK to enter and show : -3/-2/-1/+0.0/+1/+2/+3**
- 4 Press on the **UP** or **DOWN** button to make your selection
- 5 Press on **OK** to confirm your entry and exit to setting
- 7 Press on  twice to exit Setting and back to recording mode



Auto Record

This function enables your device to start recording automatically when you start the vehicle without the hassle to manually to press the recording button to start record.

- 1 Press on  once to enter video setting()
- 2 Press on **UP** or **DOWN** button to navigate to the function that shows **Auto Record**
- 3 Press on **OK to trigger: OFF / ON**
- 4 Press on  twice to exit Setting and back to recording mode



Date/Time Watermark

You have an option to display your time and date in your videos. Date and Time stamp will not be able to remove once you have activated this feature.

- 1 Press on  once to enter video setting()
- 2 Press on **UP** or **DOWN** button to navigate to the function that shows **Date/Time Watermark**
- 3 Press on **OK to trigger: OFF** / **ON**
- 4 Press on  twice to exit Setting and back to recording mode

Motion Detector

This function enables you to use your device as a remote surveillance camera with motion detection functionality. It uses the built-in camera to detect movements in the surrounding area using an advanced motion detection algorithm. Camera will auto record If it detects any movement. Activate function you will see  icon in the screen

- 1 Press on  once to enter video setting()
- 2 Press on **UP** or **DOWN** button to navigate to the function that shows **Motion Detection**
- 3 Press on **OK to trigger: OFF** / **ON**
- 4 Press on  twice to exit Setting and back to recording mode

Alternatively, you can choose using the hot keys for shortcuts

Hot Keys during recording mode:





- Press on **UP** button – Press and hold to change and once activate will see the  icon on the screen

Plate Number



Set the Car number plate for video recording information of your own vehicle for better assurance and reality on the video footage.

- 1 Press on  once to enter video setting ()
- 2 Press on **UP** or **DOWN** button to navigate to the function that shows **Plate Number**
- 3 Press on **OK** to enter and show 8 empty slot for input (in turn off mode).
- 4 Press on **OK** button to turn on mode for changing (default letter/numeric will be seen).
5. Press **UP / DOWN** button to trigger for input
6. Press **UP / DOWN** button to make the selection and press **OK** to go to the next slot which you will see an icon red pointing at.
7. Repeat point 6 till the last entry and exit to Setting (Empty Slot could use selection between letter 0 and A)
- 8 Press on  twice to exit Setting and back to recording mode

SYSTEM SETTING (Video/Photo)

Gravity Sensing (G Sensor)

This function acts like an accelerometer. It measures the acceleration and gravity forces detected on the camera. At such case during recording, the device will auto do a file lock. We recommend you to set [low]

- 1 Press on  twice to enter system setting()
- 2 Press on **UP** or **DOWN** button to navigate to the function that shows **G Sensor**
- 3 Press on **OK** to enter and show : **Close/ Low/ Medium/ High**
- 4 Press on the **UP** or **DOWN** button to make your selection
- 5 Press on **OK** to confirm your entry and exit to setting
- 6 Press on  once to exit Setting and back to recording mode



Alternatively, you can choose using the hot keys for shortcuts

Hot Keys during recording mode:

- Press once on the  button to turn manually lock the recording file you wish to save without overwritten happen till card is manually format or delete.

Record Sound

You may choose to turn off the microphone so that all the recorded videos will be muted.

- 1 Press on  twice to enter system setting()
- 2 Press on **UP** or **DOWN** button to navigate to the function that shows **Recording Sound**

- 3 Press on **OK to trigger: OFF** / **ON**
- 4 Press on  once to exit Setting and back to recording mode



Alternatively, you can choose using the hot keys for shortcuts

Hot Keys during recording mode:

- Press on **DOWN** button – Press to mute/ unmute the microphone during or before recording.



Volume

This function is to turn lower or higher volume of the device start up and button sound effect when press.

- 1 Press on  twice to enter system setting()
- 2 Press on **UP** or **DOWN** button to navigate to the function that shows **Volume**
- 3 Press on **OK** to enter and show : **Low/ Medium/ High**
- 4 Press on the **UP** or **DOWN** button to make your selection
- 5 Press on **OK** to confirm your entry and exit to setting
- 6 Press on  once to exit Setting and back to recording mode



Keystone

You may choose to turn off/on the sound of the button aside from the Volume control function.

- 1 Press on  twice to enter system setting()
- 2 Press on **UP** or **DOWN** button to navigate to the function that shows **Recording Sound**
- 3 Press on **OK to trigger: OFF** / **ON**
- 4 Press on  once to exit Setting and back to recording mode



Light Frequency

Please set according to the local power supply respectively; 50Hz or 60Hz.
RECOMMENDED : 50Hz (Mainly use for Asia)

- 1 Press on  twice to enter system setting()
- 2 Press on **UP** or **DOWN** button to navigate to the function that shows **LIGHT FREQUENCY**.
- 3 Press on **OK** to enter and show : **50Hz/ 60Hz**
- 4 Press on the **UP** or **DOWN** button to make your selection
- 5 Press on **OK** to confirm your entry and exit to setting
- 6 Press on  once to exit Setting and back to recording mode



Card Information

This function allows to check the capacity of the Sd card (used/total/SOS) and also can be used to check speed test for the existing sd card (Read and Write)

- 1 Press on  twice to enter system setting()
- 2 Press on **UP** or **DOWN** button to navigate to the function that shows **Card Info**.
3. Press on **OK** to enter and show information as mention :
 - i : **Use/Total** – this show the usage of the total file recorded size (Use) and the actual capacity of the Sd card in total could recorded (Total)
 - ii : **SOS File Take** – Capacity of the lock file could use to record (will base on estimate 25% of total file capacity for SOS)
 - iii : **Card Speed Test** – to test the read and write speed of the Sd card
- 4 For Speed test, press **UP/DOWN** follow by **OK** to select and test
- 5 Press on  once to exit Setting and back to recording mode

Language



The available language may vary depending on the region.

- 1 Press on  twice to enter system setting()
- 2 Press on **UP/DOWN** button to navigate to the function that shows **Language**
- 3 Press on **OK** to enter and show:
Chinese/English/Japanese/Korean/Russian
- 4 Press on the **UP** or **DOWN** button to make your selection
- 5 Press on **OK** to confirm your entry and exit to setting
- 6 Press on  once to exit Setting and back to recording mode

Date/ Time Setup



Access the following settings to change the device's time and date.

If the battery remains fully discharged or removed from the device, the time and date is reset.

- 1 Press on  twice to enter system setting()
- 2 Press on **UP/DOWN** button to navigate to the function that shows: **Date**
- 3 Press on **OK** to enter and show : **YYYY/MM/DD HH:MM:SS**
- 4 Press on the **UP** or **DOWN** button to change the date and time accordingly.
- 5 Press on **M** button to shift entry into the next segment. (eg. YYYY>MM)
- 6 Repeat step 4 and 5 to change accordingly until exit out from function.
- 6 Press on  once to exit Setting and back to recording mode

Screen Saver

Select timer duration for the LCD to turn off after recording starts.

- 1 Press on  twice to enter system setting()
- 2 Press on **UP** or **DOWN** button to navigate to the function that shows **Screen Saver**
- 3 Press on **OK** to enter and show: **10Sec/ 20Sec/ 30Sec/ Close**
- 4 Press on the **UP** or **DOWN** button to make your selection
- 5 Press on **OK** to confirm your entry and exit to setting
- 6 Press on  once to exit Setting and back to recording mode



Alternatively, you can choose using the hot keys for shortcuts

Hot Keys during recording mode:



- Press once to turn off/on the LCD screen with continuous recording

Restore Factory Setting (Default Setting)

Set the system parameters to the default value.

- 1 Press on  twice to enter system setting()
- 2 Press on **UP** or **DOWN** button to navigate to the function that shows **Restore Factor Setting**
- 3 Press on **OK** to enter and show: **Confirmation or Cancel**
- 4 Press on the **UP** or **DOWN** button to make your selection
- 5 Press on **OK** to confirm your entry and exit to setting
- 6 Press on  once to exit Setting and back to recording mode

Playback Mode (Video)

- 1 Stop recording by pressing on the **OK** button
- 2 Press **M** button twice switch from recording to playback mode 
- 3 Press and hold **UP** or **DOWN** button to navigate through the video/photo files (Video File will have the icon  in the centre of the screen)
- 4 Press on **OK** once you have found the file and start playback
- 5 Press on **OK** again to **PAUSE** playing and **M** or  button to **STOP** playing
- 6 **FAST FORWARD**: Press the **DOWN** button to forward your video by 2sec with each press
- 7 **REWIND** : Press the **UP** button to roll back your video play by 2sec with each press

Note : Manual lock of the video footage by pressing the manual lock  icon once to lock or unlock the footage.

Delete Files

To delete one particular file



1. Stop recording by pressing on the **OK** button
2. Press **M** button twice switch from recording to playback mode 
3. Press and hold **UP** or **DOWN** button to navigate through the video/photo files
- 3 Press on  to select this file for delete
- 4 Press on **UP/DOWN** button to select : **Confirmation / Cancel Delete**

PHOTO SETTING

Photo Resolution





- 1 Press on **M** button once into Photo Mode
- 2 Press on  once to enter Photo Setting
- 3 Press on **UP** or **DOWN** button to navigate to the function that shows **Photo Resolution**
- 4 Press on **OK** to enter showing **12MP/8MP/5MP/2MP**
- 5 Press on the **UP** or **DOWN** button to make your selection
- 6 Press on **OK** to confirm your entry and exit to setting
- 7 Press on  twice to exit Setting and back to photo mode





Photo Compression Quality

This function enable to set a quality of the photo shot require

- 1 Press on **M button** once into Photo Mode
- 2 Press on  once to enter Photo Setting
- 3 Press on **UP** or **DOWN** button to navigate to the function that shows **Photo Compression Quality**
- 4 Press on **OK** to enter showing: **General/Good/Very Good**
- 5 Press on the **UP** or **DOWN** button to make your selection
- 6 Press on **OK** to confirm your entry and exit to setting
- 7 Press on  twice to exit Setting and back to photo mode

White Balance

This function enable to select the balancing of the lighting effect on different environment. Recommendation to be set as **(AUTO)**

- 1 Press on **M button** once into Photo Mode 
- 2 Press on  once to enter Photo Setting()
- 3 Press on **UP** or **DOWN** button to navigate to the function that shows **White Balance**
- 4 Press on **OK** to enter showing:
AUTO/SUNNY/CLOUDY/INCANDESCENT/FLUORESCENT
- 5 Press on the **UP** or **DOWN** button to make your selection
- 6 Press on **OK** to confirm your entry and exit to setting
- 7 Press on  twice to exit Setting and back to photo mode

Exposure

Adjust exposure (Dimmer or brighter) according to your preference on the photo shot taken. Recommended will be neutral set at +0.0 (Default)









- 1 Press on **M button** once into Photo Mode 
- 2 Press on  once to enter Photo Setting()
- 3 Press on **UP** or **DOWN** button to navigate to the function that shows **Exposure**
- 3 Press on **OK to enter and show : -3/-2/-1/+0.0/+1/+2/+3**
- 4 Press on the **UP** or **DOWN** button to make your selection
- 5 Press on **OK** to confirm your entry and exit to setting
- 7 Press on  twice to exit Setting and back to photo mode

Photo Watermark

You have an option to display your time and date in your photo taken. Date and Time stamp will not be able to remove once you have activated this feature.

- 1 Press on **M button** once into Photo Mode 
- 2 Press on  once to enter Photo Setting()
- 3 Press on **UP** or **DOWN** button to navigate to the function that shows **Date/Time Watermark**
- 4 Press on **OK to trigger: OFF** / **ON**
- 5 Press on  twice to exit Setting and back to photo mode

Question	Reason	Solution
The captured image is not stored	<ol style="list-style-type: none"> 1 MicroSD card might be full or malfunction. 2 Image is not saved before the power outage. 	<p>Reformat the card or replace a new MicroSD</p> <p>Make sure to stop recording before shutting down.</p>
All buttons are invalid	<ol style="list-style-type: none"> 1 Procedural error or faulty Operation 2 MicroSD Card might be error or faulty 	<p>Press RESET button to restart the DVR.</p> <p>Change a new Sd card or reformat the card</p>
Device cannot be turn on	Device might be low in battery.	Charge the Battery.
Unable to record videos	<ol style="list-style-type: none"> 1 Memory card might be full. 2 If loop recording has been enabled, memory card might be corrupted. 	<ol style="list-style-type: none"> 1 Check your memory card's space. Delete files if required. 2 Reformat your Memory card , if issue still persists, replace a new memory Card
Auto stop recording in video mode	Use a compatible SDHC microSD card for HD video recording.	Get a microSD card that has minimum 8GB Class 10 speed.
Encounter "file error" when trying to playback pictures or videos	MicroSD card might be corrupted. There bad sectors in the card.	Reformat the memory card.

Question	Reason	Solution
No image is displayed on a high-definition TV screen	1 Cable plug might not be plugged in properly. 2 Wrong TV Input mode	1 Ensure AV/HDMI cable is plug into the TV properly. 2 Refer to the back panel of your TV to Track the correct TV input. Make sure you have selected the correct input.
Hazy Images	Lens might be dirty.	Check if there are fingerprints or dust on the lens. Clean it with a micro fabric cloth if necessary.
There are horizontal stripes interference on the image	This could be due to wrong light frequency setting	Please set according to the local power supply respectively;50Hz or 60Hz. For SG/MY:50hz
No image is displayed on a high-definition TV screen	1 Cable plug might not be plugged in properly. 2 Wrong TV Input mode	1 Ensure AV/HDMI cable is plug into the TV properly. 2 Refer to the back panel of your TV to track the correct TV input. Make sure you have selected the correct input.